

UNITED STATES ARMY INFANTRY SCHOOL

Fort Benning, Georgia

6 February 1967

OPERATIONS OF COMPANY B, 1ST BATTALION (AIRBORNE), 12TH
CAVALRY, 1ST CAVALRY DIVISION (AIRMOBILE), ON A SEARCH AND
DESTROY OPERATION ON 12 AND 13 FEBRUARY 1966 IN BINH DINH
PROVINCE, REPUBLIC OF VIET NAM. (PERSONAL EXPERIENCE OF A
COMPANY COMMANDER.)

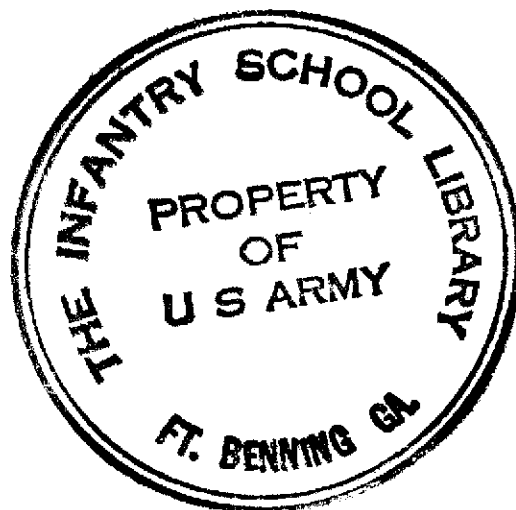

Captain Stephen Klein

Career Course Class No 1-67

Roster No 104, Advisory Group No 11

TABLE OF CONTENTS

	<u>PAGE</u>
TABLE OF CONTENTS.....	i
INTRODUCTION.....	1
General Situation.....	1
The Division Plan.....	1
The Existing Military Situation.....	2
The Brigade Plan.....	4
The Battalion Plan.....	5
The Company Plan.....	6
The Preparation.....	7
NARRATION.....	10
Operations on 12 February.....	10
Movement to Contact, 13 February.....	11
Major Contact, 13 February.....	14
Fire Support.....	16
Scheme of Maneuver.....	19
Attack.....	20
Consolidation and Results.....	21
Subsequent Activities on Operation EAGLE'S CLAW.....	23
ANALYSIS AND CRITICISM.....	24
Company Tactics.....	24
Fire Support.....	25
Scout Helicopters.....	27
Enemy Disposition.....	28
Results of Operation EAGLE'S CLAW.....	28
LESSONS LEARNED.....	29
ANNEXES: A (Task Organization).....	30
B (Key Personnel).....	31
C (Losses on Operation EAGLE'S CLAW).....	32
MAPS: A (Situation Prior to 1st Cavalry Division's Opns)	
B (1st Cavalry Division's Operations)	
C (1-12 Cavalry Plan of Operation)	
D (B Company's Operations on 12 February)	
E (B Company's Movement to Contact on 13 February)	
F (Friendly and Enemy Dispositions on 13 February)	
G (The Assault on 13 February)	
H (Consolidation on 13 Feb; Activities on 14/15 Feb)	

INTRODUCTION

GENERAL SITUATION

The coastal plain and the valleys adjoining the city of BONG SON, BINH DINH Province, had long been a Viet Cong stronghold. This rice-rich area provided the Viet Cong (VC) and their masters, the North Vietnamese Army (NVA), both a supply base, from which to extract food and revenue from a passive peasantry, and a sanctuary, in which to train, rest, and prepare future operations. (See Map "A")

Government control of this area was limited to the district capital of BONG SON, where the 41st Infantry Regiment of the Army of the Republic of Viet Nam (ARVN) was garrisoned. This regiment seldom ventured forth from BONG SON; its hold on the area, therefore, was only tenuous.

In January 1966 the 1st Cavalry Division (Airmobile) was charged with the mission of conducting search and destroy operations in northeastern BINH DINH Province, in conjunction with ARVN and other US forces, of such a nature as to dominate the area and to contribute to government pacification efforts in the SONG BA and SONG CAN valleys.

THE DIVISION PLAN

The operation was conducted in three separate phases. (See Map "B") The first phase, Operation MASHER, involved only the 3d Brigade. It made solid contact with the enemy north of BONG SON in late January. After several days of hard fighting, the enemy broke contact with the 3d Brigade and disappeared. The second phase, Operation WHITEWING, involved the 2d and 3d Brigades. They conducted airmobile assaults westward into the AN LAO valley, where the enemy was reported to be in strength. Apparently forewarned, the enemy again eluded the 1st Cavalry Division and escaped into the surrounding mountain areas.

In early February though, intelligence reports indic-

ated that sizeable enemy units could be found in the KIM SONG valley complex, located approximately 15 kilometers south of the AN LAO valley and 20 kilometers southwest of BONG SON. The KIM SONG valley complex, due to its tortuous shape, was commonly called the EAGLE'S CLAW. Therefore, this third, and final, phase of the division's operation was termed Operation EAGLE'S CLAW.

THE EXISTING MILITARY SITUATION

Like the rest of the BONG SON area, the EAGLE'S CLAW had long been under NVA/VC control. The local villagers, while not necessarily hostile to US and ARVN forces, had not, shall we say, had an opportunity to demonstrate their loyalty.

US intelligence believed that the 18th Regiment (NVA) was in the area; intelligence had strong indications that elements of the 2d Regiment (VC) were there, also.

Generally, the NVA units were better and more uniformly equipped than were their VC allies. The VC, however, were wiler fighters, were more familiar with local terrain, were better at camouflage, and were more adept at evasive actions. The NVA had both the virtues and the faults of a conventional military force: they were likely to defend on obvious terrain features; they would stand and fight more readily than would the VC; they would expectedly use normal evacuation routes; and they would probably try to maintain some unit integrity, rather than completely fragment, should they be ordered to evade. In short then, the NVA were more predictable than the VC. Of late, however, these lines of distinction had become blurred. The enemy high command had been mixing NVA and VC in the same units, in an apparent attempt to flesh out with their available resources some NVA units that had been badly hurt in recent operations against Allied forces.

The enemy had been using the EAGLE'S CLAW as a training base and as a marshalling area. Intelligence sources had located suspected sites of rice caches, arms dumps, and hospital areas; also, they believed that a NVA heavy machine gun company was based in the valley system and that its weapons were intended for use against the division's helicopters.

A total of perhaps 3,000 enemy soldiers was suspected to be in the valley of the EAGLE'S CLAW. These troops were believed to be from other units than those engaged by the 3d Brigade on Operation MASHER, several weeks before. If this were true, the enemy would be at a high level of strength, and would be well-fed and well-equipped. Finally, despite the enemy's strength, they would probably try to evade decisive engagement, if the US forces did not fix them in position.

The valley floors of the EAGLE'S CLAW were mostly rice paddies, flooded to boot-top depth. The narrow dikes enclosing the paddies provided the enemy places in which he could position automatic weapons; these weapons would then have excellent fields of grazing fire across the flat rice paddies. Several small villages dotted the valley floors. The coconut palms in these villages allowed the enemy observation posts; the houses in the villages and the usual bomb shelters beneath could give him cover and concealment. A series of small rivers meandered sluggishly across the valleys. They were only about knee-deep and from five to ten meters wide. However, the banks of these rivers were abrupt and about two meters high; if the rivers were covered by effective small arms fire, they would be formidable obstacles.

The surrounding hills were high, steep, and covered by dense vegetation. These hills would be an obstacle to conventional military units, but could be a haven to small

groups of guerillas trying to escape. Small hummocks, covered by tall grass were located randomly throughout the valleys. They offered a defender the advantages of observation, concealment, and excellent fields of fire.

In summary, if the enemy decided to evade once again, they would probably move into the surrounding hills; if they elected to stand and fight, they would defend from a village or a hummock.

THE BRIGADE PLAN

The 3d Brigade was given the mission to conduct Operation EAGLE'S CLAW. Since the enemy had withdrawn from or eluded the US forces in the previous two phases, the brigade commander decided upon a plan that would, if successful, fix the enemy in place where he could then be destroyed.

The plan entailed placing company-sized blocking positions astride the tip of each valley. The valleys were assumed to be the enemy's withdrawal routes. These blocking forces were to land by helicopter inobtrusively, move stealthily to their blocking positions, and maintain their positions in secrecy until they made contact with a large enemy force. Their directions included avoiding engaging small parties of NVA or VC.

Other company-sized forces - called pusher forces - were then to move up the valleys with a great show of force, use artillery fires extensively before them, and drive the enemy into the blocking forces. These pusher forces were instructed to avoid decisive engagement until they had pinned the enemy against a blocking force.

But before either the blocking or pusher forces were landed, a fire base was to be established at the "wrist" of the EAGLE'S CLAW, a location named Landing Zone BIRD. The supporting artillery, a temporary helicopter laager area, and various command and control echelons would be placed at LZ BIRD.

To accomplish this mission, the 3d Brigade Commander had attached three infantry battalions: the 1st Battalion (Airborne), 12th Cavalry; the 1st Battalion, 7th Cavalry; and the 2d Battalion, 7th Cavalry. Supporting these battalions from LZ BIRD would be the 3d Brigade's normal direct support artillery, the 1st Battalion, 21st Artillery (105 mm howitzer); reinforcing this battalion, and also located at LZ BIRD, was a nondivisional 155 mm howitzer battery. In addition to the infantry battalions and the cannon artillery, the brigade was to be supported by OH-13 scout helicopters from the division's reconnaissance squadron, by aerial rocket artillery (ARA) helicopters from the ARA battalion, and by lift helicopters from the assault helicopter battalions. It was, all things considered, a normal brigade task force. (See Annex "A", Task Organization.)

The brigade scheme of maneuver was as follows: the 2-7 Cavalry would seize LZ BIRD by airmobile assault; the artillery and headquarters elements would move into LZ BIRD when it was secure; next, the blocking forces from the 1-7 Cavalry and the 1-12 Cavalry were to be landed near their blocking positions; finally, the pusher forces were to land on various landing zones near LZ BIRD and then fan out up the valleys toward the blocking forces.

THE BATTALION PLAN

The 1st Battalion (Airborne), 12th Cavalry had not been heavily engaged in either of the two previous phases - MASHER and WHITEWING. It was thus chosen to clear the major area of the EAGLE'S CLAW.

The battalion had attached A Company, 2-7 Cavalry. This company and A and C Companies, 1-12 Cavalry, were to be the blocking forces. B Company was to be the pusher force. D Company (Combat Support) was to help secure the battalion headquarters at LZ BIRD. (See Map "C")

THE COMPANY PLAN

After the battalion's blocking forces were landed, B Company was to be airlifted by twenty-five UH-1D helicopters from its position in the AN LAO valley south to LZ JIM and landed within sight of LZ BIRD. No enemy resistance was expected on LZ JIM, so no fire support was planned on the landing zone. The total flight time from the AN LAO valley to LZ JIM was expected to be about twenty minutes. The landing was scheduled for 1100 hours, 12 February 1966.

The battalion commander considered landing B Company further south, into the mouth of the valley, but he feared that enemy units might be bypassed. A more northerly landing zone was, therefore, selected. The air movement was such a routine affair that it will not be discussed here. Once on the ground, the company was to move on as broad a front as possible. The company commander hoped to employ three platoons on line and further specified to his platoon leaders that they employ three squads on line. He intended, by this formation, to sweep the entire valley floor, bypassing no enemy. Should the terrain require that the platoons alter these formations, the company commander could readily grant permission over the radio. Each platoon was given certain areas of interest to thoroughly check along their routes: villages, key hills, etc. No reserve was employed because the company commander believed that the formation was wide enough to outflank any small pocket of resistance encountered. The Mortar Platoon was to follow the center platoon, by bounds and on order.

The left and right platoons were further directed to screen the wooded hills on either side of the valley. Frontal security would be provided by two OH-13 helicopters from a scout section in the division reconnaissance squadron.

The artillery forward observer was instructed to call in fire on key hills to either flank as the ^{approached} company / them; the commander hoped, by this measure, both to flush the enemy before him and to prevent any enfilading fire. The FO could also call upon ARA helicopters, if necessary. More detailed plans than this were not required.

THE PREPARATION

On 11 February, the day prior to the operation, the battalion commander, the S-3, and the company commanders made an aerial reconnaissance of the EAGLE'S CLAW. To preclude enemy detection of the impending operation, the brigade commander limited reconnaissance to one helicopter for each battalion and to one overflight for each helicopter. The company commanders were able to get a general idea of their areas of operations and to make recommendations to the battalion commander as to their landing zones and schemes of maneuver.

After the reconnaissance flight, the battalion commander issued a verbal operations order. The B Company Commander was able to make all necessary coordination at that time, including making arrangements with the helicopter flight leader on formations to be used at the pickup and landing zones. Most of the other coordination matters, i.e., frequencies, call signs, fire requesting, emergency signals, etc., were a matter of SOP within the division and battalion and required no special arrangements.

Once back at his company area in the AN LAO valley, the company commander issued his order to the subordinate leaders. His order covered those matters already mentioned in THE COMPANY PLAN.

Supplies were always maintained at a constant operating level by the company executive officer and required no special adjustment for this operation: the

basic load had been replenished, each man had three C-ration meals, and each radio operator carried an extra battery for his AN/PRC-25 radio. One deficiency did exist in the men's clothing, however. The company had been in the field for almost three weeks and jackets, trousers, and - most importantly - boots were showing significant wear. A few replacement items had been delivered, but not enough to really improve the situation. B Company was very tattered.

Three peculiarities existed in areas which had a bearing on the subsequent action: 90 mm rifles, the Mortar Platoon's organization and fire direction net, and personnel.

Each rifle platoon was authorized two 90 mm recoilless rifles in its weapons squad. However, on all previous operations, these weapons, due to their size and weight, had been left in the division base camp. On this operation, one 90 mm rifle was carried by each platoon because the open terrain in the rice paddies might afford an opportunity to use the great firepower of these weapons.

The division SOI allowed each company's mortar platoon a fire direction frequency. B Company did not use a separate fire direction net. Instead, the radios that the FO's carried were set on the company command net. This allowed the rifle platoon leaders an extra radio in their platoons. Fire requests were sent over the company command net. Although this cluttered the command net, the added control that the extra radio afforded each rifle platoon leader more than compensated for any lack of responsiveness from the Mortar Platoon's fires.

On this operation, as on all previous ones, the Mortar Platoon carried only one of its three mortar tubes. One of the free mortar squads carried ammunition - approxi-

mately 30 rounds; the other mortar squad served as a security force. This arrangement was common among US infantry units in Viet Nam.

B Company's personnel situation was excellent. It was at almost 80 percent of its authorized strength - a strong showing. But the company's true strength lay in its experience. Nearly all the personnel had served in the same company since back at Fort Benning, nearly six months before. Most of the platoon sergeants and squad leaders had served together in B Company for three years or more. Mutual confidence existed among all ranks. Strengths were known and appreciated; weaknesses were recognized and allowed for.

Preparation was complete for Operation EAGLE'S CLAW. Supplies had been issued; equipment had been checked; morale was high. B Company had never been better prepared.

NARRATION

OPERATIONS ON 12 FEBRUARY

The 2d Battalion, 7th Cavalry had a fight on its hands at LZ BIRD. Since the phasing of the entire operation depended upon the brigade first securing an artillery base from which subsequent actions could be supported, the 1-12 Cavalry could not begin its movement from the AN LAO valley until the 2-7 Cavalry had secured its objective, LZ BIRD. The entire operation was delayed several hours. B Company, which had expected to land at LZ JIM by 1100 hours, did not actually lift off until 1400 hours, 12 February.

The air movement went routinely. The promised number of helicopters, 25 UH-1D's, arrived at the pickup zone. The air column quickly gained its flight altitude, about 2,000 feet, sufficient to keep it out of small arms fire range, and it maintained this altitude almost all the way to the landing zone.

Upon touching down at LZ JIM, the platoons set up their usual company perimeter defense and checked to see if any helicopters had dropped out enroute.

The company commander had hoped to progress halfway up the valley before sundown, but he immediately realized that the delay in starting the operation precluded such a goal; instead, he selected, from a map reconnaissance, a Cao Dai pagoda, set on a small hill, as the company's position for the night. (See Map "D") To secure this position, about 1,000 meters south of LZ JIM, he sent the 2d and 3d Platoons maneuvering east and west, respectively, to clear some larger hills commanding the pagoda area. The 1st Platoon, followed by the command group and the Mortar Platoon, proceeded straight south toward the pagoda.

No enemy contact was made, and by 1600 hours the company had closed into a perimeter defense. Local security

was put out several hundred meters in all directions, and the company spent an uneventful night.

MOVEMENT TO CONTACT, 13 FEBRUARY

By 0730 hours on 13 February the company started up the valley again. The platoons were disposed three abreast across the valley, 2d, 1st, and 3d, from left to right; the command group and Mortar Platoon again followed the 1st Platoon, in the center. The 3d Platoon was directed to devote most of its attention to guarding the right flank, which was commanded by high, thickly vegetated hills. Consequently, two of its squads were put into the woodline and only its third squad remained in the open valley. (See Map "E")

The first obstacle was the village of KIM SON (2). The 1st Platoon swept through it and discovered signs of recent enemy occupation: a deep trench across the middle of the village, oriented north and freshly dug; scattered 7.62 mm CHICOM ammunition; VC flags and propaganda posters; and finally, an officer's swagger stick. A few villagers remained in their houses. When the villagers were questioned by the Psywar Team interpreter about recent enemy activity, they professed ignorance and claimed that neither VC nor NVA had been in their village for weeks... although evidence to the contrary was everywhere evident.

Two OH-13 scout helicopters reported for instructions. The commander told them to circle in front of company and to screen its forward movement.

As the 1st Platoon approached the southern edge of the village, the scout ships reported that four men were hiding in foxholes just in front of the 2d Platoon. The 2d Platoon had not yet seen the men, but when the platoon leader was informed of their location, he sent fire teams out front

to engage them. They offered no resistance to capture, and were without weapons. Because they were of military age and had been hiding, the commander considered them to be Viet Cong suspects (VCS); he reported their capture as such to battalion. After only a few scant minutes, a helicopter arrived, picked up the four VCS, and returned them to LZ BIRD for detailed interrogation.

About 1030 hours B Company started moving again. It had proceeded no more than 100 meters, when the scout ships reported that they were being fired upon from the village of PHU NINH (1), 600 meters across the valley to the south. The commander told them to make further passes over the village, but not to fire into it unless they continued to draw fire. After several more passes, the two scout ships reported that, although they were still being shot at, they could not pinpoint the source from which the fire came. They then returned to their base to refuel.

The commander realized that the company could not proceed up the valley without first eliminating the sniper. He sent the 2d Platoon to clear PHU NINH (1) and to eliminate the sniper. The other platoons were to remain in position, but were told to be ready to assist the 2d Platoon if it uncovered a larger force than it could handle.

The 2d Platoon moved by battle drill formation across the open rice paddies, but without drawing further fire. When the platoon gained the cover of a palm grove adjoining the village, the Psywar Team, which had accompanied the platoon, broadcast into the village. The villagers were instructed to stand outside their houses and were warned that if the platoon were fired at, artillery fire would be directed against their homes. The 2d Platoon then moved through the village, quickly searching it, but without finding either the sniper or his weapon.

While the 2d Platoon was clearing PHU NINH (1), the rest of the company started moving again. The 1st and 3d Platoons wheeled to their right following the valley, and shortly came abreast of the 2d Platoon again. As the company moved up the valley, westward now, the Mortar Platoon followed by bounds, about three or four hundred meters behind. It kept its mortar trained on PHU NINH and had instructions to immediately fire upon the village should the sniper start shooting again. The two scout ships had still not returned from their refueling.

At about 1230, two interesting things happened. First, while A Co, 2-7 Cav, was moving toward position LEAD, it uncovered a very large enemy arms dump. More than six CH-47 helicopter sorties were required to evacuate everything that had been found. In addition to the many small arms and anti-tank weapons, a large number of heavy machine guns was found in the arms dump. This discovery lent further credence to the earlier intelligence reports that sizeable NVA/VC forces were based in the EAGLE'S CLAW.

The second item of interest was received from the battalion S-3. He radioed B Company that an Aerial Rocket Artillery (ARA) helicopter had spotted enemy heavy machine gun positions about 1,000 meters up the valley and that it had been fired on from this same general location. The company was directed to "check out" the area. These directions resolved for the company commander the question of in which direction the company was to go when it reached the fork in the valley: it was to continue due west toward position GOLD, occupied by C Company, 1-12 Cavalry.

Expecting imminent contact, the commander moved the 2d Platoon from its left flank position to a reserve position behind the first platoon. The company now had only two platoons abreast, but it had a reserve platoon which could be maneuvered to either side.

The two scout ships had still not returned from refueling, but the artillery FO had established radio contact with the ARA ship (a UH-1B helicopter armed with forty-eight 2.75-inch rockets). It was orbiting over an area 2,000 meters west of the company. B Company moved ahead, toward that location.

MAJOR CONTACT, 13 FEBRUARY

It was about 1330 hours when the company approached the village of BINH SON. The men of the 1st Platoon moved warily through the deserted hamlet, kicking open doors, peering into bomb shelters, and probing malodorous piles of straw and rice with their bayonets.

The 3d Platoon, abreast and to the right of the 1st Platoon, was in a field of high elephant grass and was approaching a finger of woods that ran down from the hills on its right. (See Map "F") The small SUOUI (river) BU NU separated the 1st and 3d Platoons, and they had temporarily lost visual contact.

The 2d and Mortar Platoons followed the 1st Platoon into BINH SON.

As the lead elements of the 1st Platoon reached the western edge of the village, they passed beneath a row of coconut trees and clambered down a bank toward another rice paddy. No sooner had the point fully exposed himself on this bank, than a hail of fire came from a hummock across the rice paddy. The men scrambled back up the bank and, from the cover of a brush fence beneath the coconut palms, began to fire back.

At the same time that the 1st Platoon became engaged, the 3d Platoon came under heavy enemy fire, also. It, too, had halted and was returning fire.

The company commander, who, with his command group, was following the 1st Platoon, directed the 2d Platoon Leader to establish flank and rear security, to hold his

present position, and to await further orders. The commander saw that the Mortar Platoon was putting its mortar into action without waiting for orders. Having quickly assured himself that the company's flanks and rear were secure, he then moved up to the brush fence and evaluated the situation.

He saw that about 200 meters of open rice paddy separated his position from the enemy force on the hummock. The hummock itself rose about six meters above the paddy, was protected at its base by the SUOUI BU NU, much in the nature of a moat, and was covered by a stand of high elephant grass. Although a brisk fire fight was occurring, 1st Platoon was beginning to identify several enemy positions on the hummock: on the crest of the hummock was a heavy machine gun, exposed intermittently as it was fired and then withdrawn back into its hole; further to the right was another automatic weapon of smaller caliber; at the extreme northern side of the hummock the enemy leader had his position and could even be seen as he would occasionally raise himself from his hole; several other enemy were identified as they exposed themselves to fire.

On the right, the 3d Platoon Leader could not so easily define the enemy opposing him; his observation was hampered by tall grass and trees. He did, however, radio the commander that he was opposed by an estimated one or two squads to his front; that he had identified, by sound, but not by location, two enemy heavy machine guns; and that he believed some snipers were in the trees near him.

Finally, both the 1st and 3d Platoon Leaders reported that no casualties had been taken in the initial contact. This, the commander later concluded, was a matter of sheer luck. The enemy had fired prematurely on the 1st Platoon and had allowed it to regain the

sanctuary of the village. Had the enemy held its fire until the 1st Platoon was deployed in the rice paddy, initial casualties would have been high.

The company commander radioed his situation to the battalion commander, reporting that his company was opposed by possibly a platoon, which was well dug-in and reinforced by three heavy machine guns. Keeping in mind that his mission included avoiding decisive engagement, he requested instructions: did the battalion commander wish B Company to attack the enemy, or merely to return the fire and allow the enemy to withdraw that night - hopefully toward C Company at position GOLD? The battalion commander's reply was quick and explicit: attack the enemy and continue movement toward position GOLD.

This was a refreshingly novel situation for B Company. All its previous engagements had occurred in thick jungle where the enemy was familiar with the terrain and where the company could only grope after its adversaries. Here in the EAGLE'S CLAW, observation was good and sufficient space existed to maneuver squads and platoons freely.

The company commander realized, ofcourse, that, in order to seize the enemy position, two tasks needed to be done: first, establish and maintain fire superiority; second, maneuver against the enemy force.

FIRE SUPPORT

By the time that the battalion commander's order to attack the enemy was received, B Company had almost achieved fire superiority. The ARA ship had been called in immediately by the artillery FO and it had fired rocket salvos against the hummock. The FO was able to direct extremely accurate fire from the helicopter, because so many enemy positions had been plainly identified. At the same time that the helicopter began attacking the hummock, the FO was placing a call-for-fire to the cannon

artillery at LZ BIRD. Since this artillery had only recently fired at nearby targets, it was able quickly and rapidly to adjust its fires onto the hummock. Within a matter of minutes, a full battalion of 105-mm howitzers, reinforced by a battery of 155-mm howitzers, was engaging the enemy. The ARA helicopter, its rocket pods emptied, returned to its base to rearm. The time was now about 1415 hours.

The battalion S-3 kept in mind that the ARA helicopter had been fired upon by heavy machine guns farther up the valley earlier in the day. These machine guns, in fact, had been B Company's objective before it became engaged. The S-3, therefore, called in tactical air strikes against these deeper positions. Two A-1E fighter-bombers began making passes over B Company and delivering their ordnance - napalm, 250 lbs. bombs, and 20-mm cannon - on these other enemy machine guns.

The two scout helicopters, which had departed that morning, now returned. The company commander directed that they orbit further up the valley, west of and beyond the enemy opposing him, and observe and fire upon any enemy trying to withdraw. He also advised them to stay out the path of the A-1E's and of the incoming artillery. Throughout the rest of the day, however, they observed no enemy.

The FO shifted the artillery fire to the right, where the 3d Platoon Leader was complaining that the sniper fire was becoming more accurate. Two battalion volleys silenced the sniper fire. The artillery was then shifted back and forth, from the enemy in front of the 3d Platoon to the enemy in front of the 1st Platoon. The volleys fired were a mixture of high explosive rounds and white phosphorous rounds; the fuses for this ammunition were either fuse-super-quick or fuse-delay.

By means of such a mixture of ammunition and fuses, the FO hoped that both surface and dug-in targets would be destroyed.

The two engaged rifle platoons had, meanwhile, not been idle. The incoming artillery was so close to their positions that the men had to seek cover when the rounds were falling. In the lulls between the artillery, they would again fire at the enemy positions.

Rather amazingly, considering the volume of artillery fire that had been directed against the hummock, the heavy machine gun was still firing back at the 1st Platoon and the enemy leader was still directing his half of the battle. The B Company Commander called the 90-mm recoilless rifle teams from the 1st and 2d Platoons over to his position. Each weapon had two rounds. After one of the nearby rifle squad leaders fired tracer rounds into these two enemy positions to identify their locations to the gunners, each 90-mm gunner then raised himself to a kneeling position and fired his two rounds - one gunner firing at the machine gun, the other firing at the enemy leader. The two positions were destroyed. The enemy was still active on the hummock, however; as one of the 90-mm gunners was firing, he was struck twice by enemy bullets, but only in his cargo pack.

The Mortar Platoon quickly set up its single mortar and reported to the commander that it was ready to accept fire missions. However, he did not use the Mortar Platoon at all in the ensuing battle. He felt that the small amount of added fire support that the mortar could give did not outweigh its disadvantages. For if the mortar fired, the trajectory of its rounds would interfere with the flight paths of the ARA helicopter and the fighter-bombers which were passing directly over B Company.

Furthermore, sufficient supporting fire was already being placed upon the enemy; indeed, further explosions on the hummock would only make the FO's job of adjusting the artillery more difficult. Finally, the company command net was already overcrowded by the platoon leaders and platoon sergeants identifying enemy positions and relaying artillery adjustments; fire missions would render the command net useless. This last reason was the overriding consideration.

SCHEME OF MANEUVER

Concurrently, while fire superiority was being gained over the enemy, the commander had been considering a scheme of maneuver. The 3d Platoon, on the right, could perhaps move forward, but it would come under observation, and probably fire, from the enemy on the hummock. The hummock, then, was the key to ^{the} valley and would have to be seized before B Company could continue its passage. A frontal assault by the 1st Platoon across two or three hundred meters of open rice paddy was unthinkable. However, the line of coconut palms, in which the 1st Platoon was deployed, continued around to the left and came within 150 meters of the southern flank of the hummock. The 2d Platoon, in reserve, was available for employment on this flank; furthermore, it had used none of its ammunition, except for the two 90-mm rounds.

Accordingly, the commander formulated his plan and issued his order. He radioed these instructions to the 3d Platoon leader, but was able to speak directly to the 1st and 2d Platoon Leaders. The 2d Platoon was to move, concealed by the palm trees, to a position as close as possible to the hummock. It was then to cross the rice paddy by battle drill formation and to assault the enemy positions on the hummock, sweeping from south to north. The 3d Platoon was directed to make what was, in effect,

a secondary attack. It was to move straight ahead, also by battle drill; however, should it encounter strong enemy resistance, it was to hold its position and return fire. The 1st Platoon was to support by fire the 2d Platoon's attack; it was to maintain a slow, but steady, volume of fire on the hummock, lifting its fires only when the 2d Platoon began its final assault. The FO was told to have the artillery at LZ BIRD continue to fire on the hummock, but to lift fires when the 2d Platoon left the concealment of the coconut palms. The company command group would follow the 2d Platoon. (See Map "G")

Developing the situation, arranging for and coordinating fire support, and issuing final orders had all taken considerable time. It was not until almost 1530 hours that the 2d Platoon of B Company began moving through BINH SON to get into position on the southern flank of the hummock.

ATTACK

The attack went according to plan. As the 2d Platoon moved out of the palm trees, the FO lifted the artillery fires. The 2d Platoon advanced steadily across the rice paddy, moving by short rushes of two or three men from dike to dike, covered by other squads. Meanwhile, the 1st Platoon kept up a steady patter of bullets on the hummock. When the 2d Platoon reached the base of the hummock, two squads formed in an assault line and swept over the crest of the hill, while the third squad provided flank security to the west. The 1st Platoon lifted its fires as the assault squads of the 2d Platoon moved forward. The fight was quickly over. Only three defenders had been still alive, and they were all readily dispatched in their holes by grenades.

The 3d Platoon met only light resistance in its

advance on the right. One of its men was slightly wounded by enemy gunfire - actually, only grazed by a bullet. The platoon swept forward over what had been the enemy positions and halted, on order, abreast of the 2d Platoon. The 1st Platoon was then called forward to establish further security on the hummock, while the 2d Platoon searched the objective area.

CONSOLIDATION AND RESULTS

The results of the attack were gratifying, if not sensational. Nine enemy bodies were found on the hummock, all in deep, well revetted holes which had strong overhead cover. Their uniforms, equipment, and personal belongings proved that they had belonged to an NVA unit. The commander had, in fact, suspected as much from the organization of their position and from their decision to stand and fight. Individual weapons for all the bodies were also recovered. The weapons were, as usual, CHICOM 7.62-mm assault rifles and carbines. The heavy machine was also found. Battered and twisted out of shape by, probably, the 90-mm rounds, it was also a CHICOM weapon, 12.5-mm in caliber. Beside the remains of the weapon itself, its large tripod, its transporting wheels, and its antiaircraft accessories were discovered.

At the position where the enemy leader had been, no body was found. A shirt was discovered in his hole, though; it was torn by shell fragments and soaked in blood. From the pocket of this shirt, two interesting documents were retrieved. One was a complete log of US helicopter overflights, describing the type of helicopter involved, the time of the flight, and the activity of the aircraft. The other document was of greater immediate significance. It was a sketch map of the position B Company had just seized. On it were indicated the positions

of the heavy machine guns and several arrows showing what were probably withdrawal routes. One such arrow indicated a withdrawal route up the valley toward position GOLD; another arrow indicated a withdrawal route into the hills to the north.

The 3d Platoon found no bodies in the position it had seized. There were, however, numerous blood trails, discarded uniforms, and over one dozen NVA knapsacks complete with personal equipment left on position. The platoon also discovered accessories for two heavy machine guns identical to the accessories that the 2d Platoon had captured. The 3d Platoon Leader believed that the enemy had withdrawn into the jungle-covered hills to the north and he suggested that the company give pursuit in that direction.

The decision was not the company commander's to make, for at this time both the brigade and the battalion commanders landed on the hummock. The brigade commander directed that B Company continue its movement up the valley toward C Company's blocking position. He was concerned about the other heavy machine gun position further west that the fighter-bombers had attacked earlier that afternoon, and he wanted B Company to start moving again so as to retrieve these weapons before the enemy could. However, the battalion commander realized that B Company needed a resupply of ammunition before it could be committed to action again. Since it was then already 1630 hours, he felt that, by the time ammunition resupply could be effected, it would be too late to start moving again. Based upon the battalion commander's recommendation, the brigade commander allowed B Company to remain overnight in its present position. (See Map "H")

Ammunition was brought in by helicopter and the one

casualty plus the captured equipment were evacuated. By 1700 hours, the company had closed into its usual perimeter defense. The enemy remains were covered with dirt in the holes in which they had died. Artillery and mortar defensive concentrations were adjusted in and local security was established. The company spent another uneventful night.

SUBSEQUENT ACTIVITIES ON OPERATION EAGLE'S CLAW

On 14 February the company moved to the end of the valley without further contact. On the way, it was able to recover one more heavy machine gun, plus numerous NVA knapsacks. When the company reached the end of the valley, it established visual and radio contact with C Company. Numerous patrols were sent out, all without finding the enemy.

B Company was transported by helicopters on 15 February to the next valley northwards. There, it conducted more patrolling for a few days, killed a few NVA, suffered a few casualties, but made no heavy contact as on 13 February.

On 18 February, the 1-12 Cavalry was placed in brigade reserve and all its companies were returned to LZ BIRD for a few days needed rest.

ANALYSIS AND CRITICISM

COMPANY TACTICS

The most rewarding aspect of the company's attack on 13 February was its success. An entrenched NVA platoon was dislodged; nine of its members, at least, were killed; one heavy machine gun was captured and two more rendered inoperable; nine smaller enemy weapons, plus numerous other items, were captured. The total cost to B Company was only one man wounded - and so slightly that he returned for duty the following day.

In a type war in which the usual battles are fought on the enemy's terms and on the enemy's terrain, here was a small example of a well executed company offensive operation - almost an Infantry School problem. It proved the soundness of the tactical doctrine of the US Army.

The only factors of the entire company operation peculiar either to the war in Viet Nam or to the 1st Cavalry Division's organization were the employment of the scout ships and of the ARA helicopters. The use of these aircraft, while important, was not decisive. All the other factors - the maneuvers of the rifle platoons, the use of supporting arms - were as taught ~~at~~ in field manuals.

The commander, unwittingly perhaps, followed the fundamentals of offensive tactics.

a. When enemy contact was gained on 13 February, it was maintained until a favorable decision had been achieved.

b. After enemy contact was made, the situation was developed by observation, fire, and continued pressure.

c. The enemy's weakness was exploited by enveloping his exposed southern flank, rather than attacking his entrenched and constricted northern flank.

d. The hummock was recognized as the key terrain and seized, forcing the enemy off his position.

e. After contact was gained, and while the situation was being developed, the commander retained the initiative by applying overwhelming combat power - in the form of massive fire support - on the enemy. He ultimately retained the initiative by attacking the enemy's position.

f. The enemy's capability to react was neutralized by having the scout helicopters observe further up the valley, thus denying the enemy an opportunity to reinforce from or withdraw in that direction. Continued fire support kept the enemy pinned in his holes.

g. Throughout the two-day operation, whenever enemy contact was expected, the platoons moved by fire and movement, i.e., by battle drill.

h. Superior combat power was concentrated at the decisive time and place by means of the 3d Platoon making a secondary - holding - attack, while the 2d Platoon, supported by the artillery and the 1st Platoon, seized the key terrain.

i. Throughout the move up the valley, the company commander provided for the security and integrity of his force by assigning flank security missions to his platoons and by using the scout helicopters for frontal security. When contact was made, he assigned the 2d Platoon a rear security mission prior to its commitment.

The commander did violate two fundamentals of offensive tactics: he neither maintained the momentum of the attack nor exploited success. Properly, he should have followed the 3d Platoon Leader's suggestion and pursued the enemy into the hills; or else he should have concurred with the brigade commander's direction to continue movement up the valley while daylight yet remained.

FIRE SUPPORT

Sound as were the company commander's applications

of the fundamentals of offensive tactics, the fight was really won by the overwhelming fire support available to B Company.

The 2.75-inch aerial rockets on ARA helicopters are not really effective against a dug-in enemy. They are, however, useful for suppressive fires, i.e., they force an enemy to keep his head down while other things are going on. The "other things", in this case, were the artillery batteries at LZ BIRD getting ready to fire.

As a general rule in Viet Nam, ARA helicopters are used for quick, suppressive fire on a target; the cannon artillery, slower because of the computations necessary at the fire direction centers, are eventually relied upon to neutralize or to destroy a target. Such was the case on 13 February.

The use of fuse-delay is not limited to attacks upon fortified or dug-in positions. In the dense jungles of Viet Nam, rounds armed with fuse-quick are activated by the topmost tree canopy and they burst well above ground level. In order to get the rounds to burst at ground level, fuse-delay is used. The .05-second delay allows the round to penetrate the foliage further before detonation. In the 3d Platoon's sector, fuse-quick was used to clean the snipers from the trees; fuse-delay was used to attack the enemy on the ground.

The A1-E fighter-bombers, while not actually attacking targets against which B Company was fighting, nevertheless succeeded in isolating the battlefield. Their quick response to the battalion S-3's call was due to the system, common in Viet Nam, of keeping several Air Force tactical aircraft overhead on "aircap".

The use of the company's Mortar Platoon, or rather the manner in which it was not used, has already been

discussed. It should be realized, though, that on 13 February B Company had a tremendous amount of artillery supporting it. Under conditions where less artillery support were available, the Mortar Platoon would certainly have been employed. A important consideration was that the Mortar Platoon's radios were, at the time, being put to better use. Were sufficient additional radios available in each rifle platoon for interior control to be exercised by the platoon leader, then the Mortar Platoon would have been able to use its own radios and thus participate in the battle. Before and after this fight, B Company put its 81-mm mortar to good use.

SCOUT HELICOPTERS

Scout helicopters had never directly supported a rifle company of the 1-12 Cavalry prior to Operation EAGLE'S CLAW. The success enjoyed on EAGLE'S CLAW, however, insured their continued supporting missions on subsequent operations.

On 13 February, the scout ships were able to detect four VCS in front of the company's formation; shortly thereafter, they drew fire from the village of PHU NINH (1) and possibly avoided an ambush of B Company's flank platoon. Had they not been refueling in the early afternoon, they probably could have given early warning of the enemy position on the hummock.

The OH-13 helicopter has such a short on-station time that two scout sections could have been more profitably employed - one at the laager area on LZ BIRD, the other two-ship section flying reconnaissance for the company. Another solution would be for an ARA helicopter to alternate with a scout section on reconnaissance missions; the single UH-1B helicopter, with a longer on-station time, could effectively supplement the OH-13 helicopters.

ENEMY DISPOSITION

The enemy's position was a curious one. He was dug-in and his holes had stout overhead cover; each emplacement was thoroughly camouflaged. All these measures were to be expected from the NVA or the VC. However, it is difficult to determine why the enemy elected to stand and fight as long as he did. His actions were those of a covering force; however, were a larger enemy force withdrawing up the valley behind the force opposing B Company, the ARA ship or the scout helicopters would certainly have observed it. Enemy dispositions were such as to cover the rice paddies to his front, should US forces land there by helicopter; however, in order to cover all the landing zones in the area, he would more logically have been disposed in an circular defense covering landing zones to his rear, as well.

In the opinion of the company commander, the enemy's position was just a harrassing defense, designed to inflict casualties upon US forces advancing up the valley and to cause the US forces to deploy. The enemy probably intended to withdraw, but was pinned down by the small arms fire, aerial rockets, and artillery fire quickly delivered on his position.

All NVA/VC forces must have realized that US infantry enjoyed a tremendous superiority in fire support. Therefore, the enemy commander was incorrect to dispose his troops in the middle of a valley; his men paid dearly for his mistake.

RESULTS OF OPERATION EAGLE'S CLAW

Although the 2-7 Cavalry captured an NVA battalion commander and engaged some enemy company-sized units, no sizeable NVA/VC force was destroyed on Operation EAGLE'S CLAW. In the 1-12 Cavalry sector, the heaviest contact was the one just described involving B Company. The other

companies, in their blocking positions, picked off only small groups trying to escape up the valleys.

Viewed in this light, the plan failed. No large enemy forces were fixed and destroyed; no large enemy forces were even located. Perhaps the plan had been too ambitious. Certainly it was realized now, as perhaps it should have realized before, that the enemy would fragment his forces, rather than face US firepower.

The operation eventually broke down into a series of squad-sized patrol actions. It was in this phase that the US forces achieved their greatest successes; for by hunting down the NVA/VC in the jungles, still supported by their artillery and airpower, the US soldiers carried the fight to the enemy.

However, when the final tallies were in, over 400 enemy had been killed - by body count - and another 400 estimated killed on Operation EAGLE'S CLAW. By anyone's estimate then, the enemy must have suffered over 1,000 casualties during the seven day operation. Such losses would effectively destroy any regiment as a fighting force.

(See Annex "C", Losses on Operation EAGLE'S CLAW)

Considering this, the operation was a success.

LESSONS LEARNED

1. The proper application of the fundamentals of offensive tactics are necessary for an attack to succeed. These fundamentals are as important in Viet Nam as they are in a more conventional setting.

2. An infantry company needs a preponderance of effective artillery support in order to attack successfully an entrenched enemy. Without this effective artillery support, an infantry unit attacking a dug-in enemy cannot hope to avoid needless casualties and will probably fail to seize its objective.

3. Artillery fired against an enemy concealed by high and dense vegetation should have fuse-delay arming so as to allow the rounds time to penetrate the canopy before detonating.

4. Aerial rocket artillery helicopters are best employed when providing rapid suppressive fire on a target.

5. Scout helicopters are a valuable tool for a rifle company commander during offensive operations. With scout helicopters supporting the company, the commander can greatly increase the range and the effectiveness of his security.

6. Escape routes chosen by NVA/VC forces will more likely lead into dense vegetation than through open valleys.

7. Prepared NVA/VC positions can be expected to have stout overhead cover; artillery will require fuse-delay arming to defeat these defenses.

STEPHEN KLEIN
Captain, Infantry

Annex B (Key Personnel)

3d Brigade

Commander COL Harold Moore

1st Bn (Abn), 12th Cav

Commander LTC Rutland Beard

S-3 MAJ William Roll

A Company Commander CPT John Drake

B Company Commander CPT Stephen Klein

C Company Commander CPT Donald McMillan

D Company Commander CPT Donald Warren

2d Bn, 7th Cav

A Company Commander * CPT Joel Sugdinis

B Company, 1st Bn (Abn), 12th Cav

Commander CPT Stephen Klein

Executive Officer 1LT Jimmie Smith

1st Sergeant 1SG Clarence Linton

1st Platoon Leader 2LT Lewis Anderson

1st Platoon Sergeant PSG David Dixon

2d Platoon Leader 1LT George Quigley

2d Platoon Sergeant SSG James Morris

3d Platoon Leader 1LT Roger Baker

3d Platoon Sergeant SSG Edward Turner

Mortar Platoon Leader (Vacant)

Mortar Platoon Sergeant SSG Frank O'Dell

B Battery, 2d Bn (Abn), 19th Arty **

Forward Observer 2LT John Piper

Reconnaissance Sergeant SGT Rufus McClain

Psywar Detachment **

Team Chief 2LT _____ Endrijonas

* Attached to 1-12 Cav

** Supporting B Co, 1-12 Cav

Annex C (Losses on Operation EAGLE'S CLAW)

	<u>Enemy</u>	<u>Friendly</u>
KIA (Body Count).....	404	20
KIA (Estimated).....	384	
WIA.....		54
Viet Cong Captives (VCC).....	60	
Viet Cong Suspects (VCS).....	369	
Individual weapons captured.....	91	
Crew-served weapons captured.....	27	

BIBLIOGRAPHY

1. Andlauer, Louis. "Air Support in Counter-Guerrilla Warfare". Journal of the United Services Institute of India. Vol LXXXI, No 384, July - September 1961.

2. Artillery Handbook. Fort Benning, Georgia: United States Army Infantry School, February 1966.

3. "1st Cav Division Operations in the SONG LAI GIANG River Valley, (24 January - 17 February 1966)". An Khe, Viet Nam: 1st Cavalry Division (Airmobile), undated.

4. Overlay, from "After Action Report, Operation Masher/Whitewing". An Khe, Viet Nam: 1st Bn (Abn), 12th Cavalry, 1st Cavalry Div (Airmobile), undated. (Personal copy of the author).

5. Tactical Operations Handbook. Fort Benning, Georgia: United States Army Infantry School, September 1966.

6. "Unit History". An Khe, Viet Nam: Co B, 1st Bn (Abn), 12th Cav, 1st Cav Div (Air), May 1966. (Personal copy of the author).

3 BDE / 1 CAV DIV

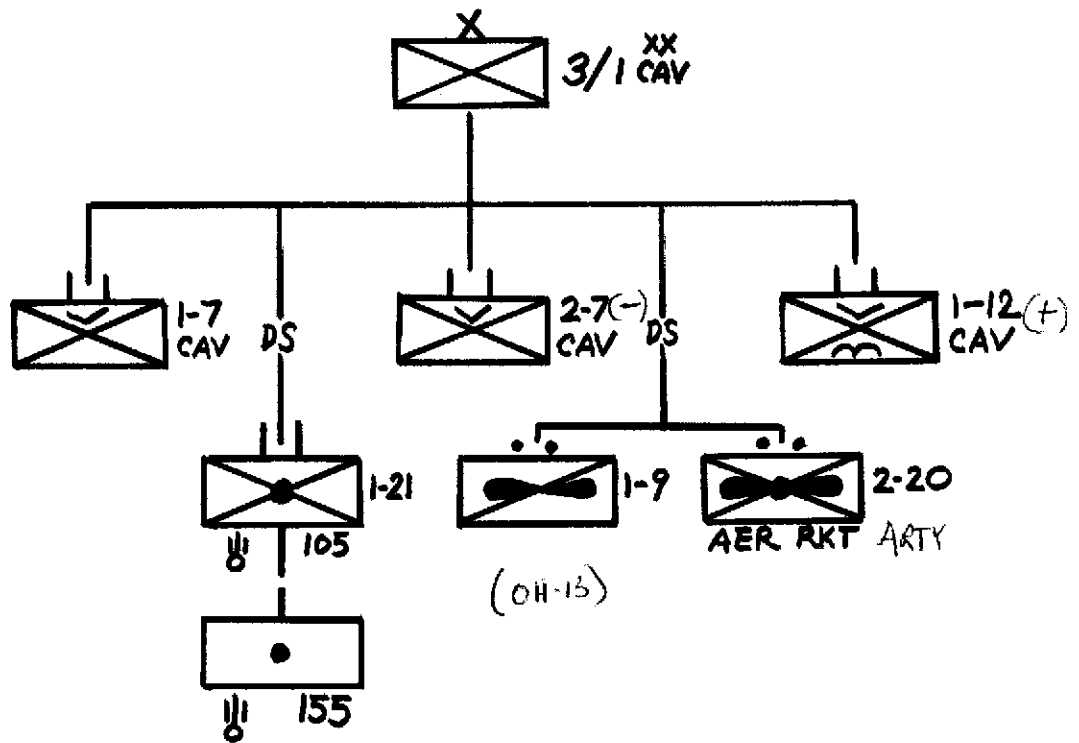

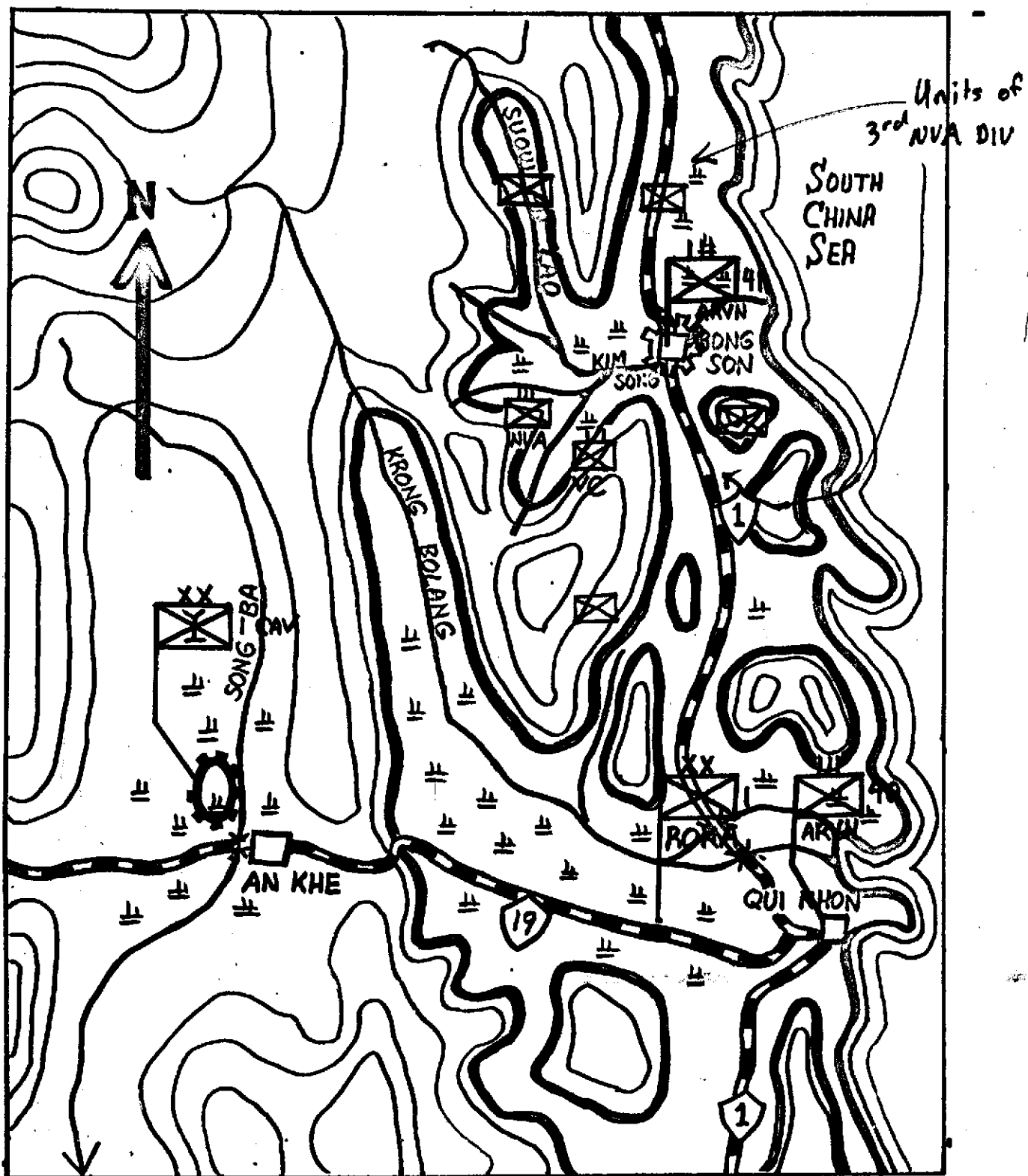

MAP "A"
 NORTHEASTERN BINH DINH PROVINCE
 (SITUATION PRIOR TO 1ST CAVALRY DIVISION'S OPERATIONS)

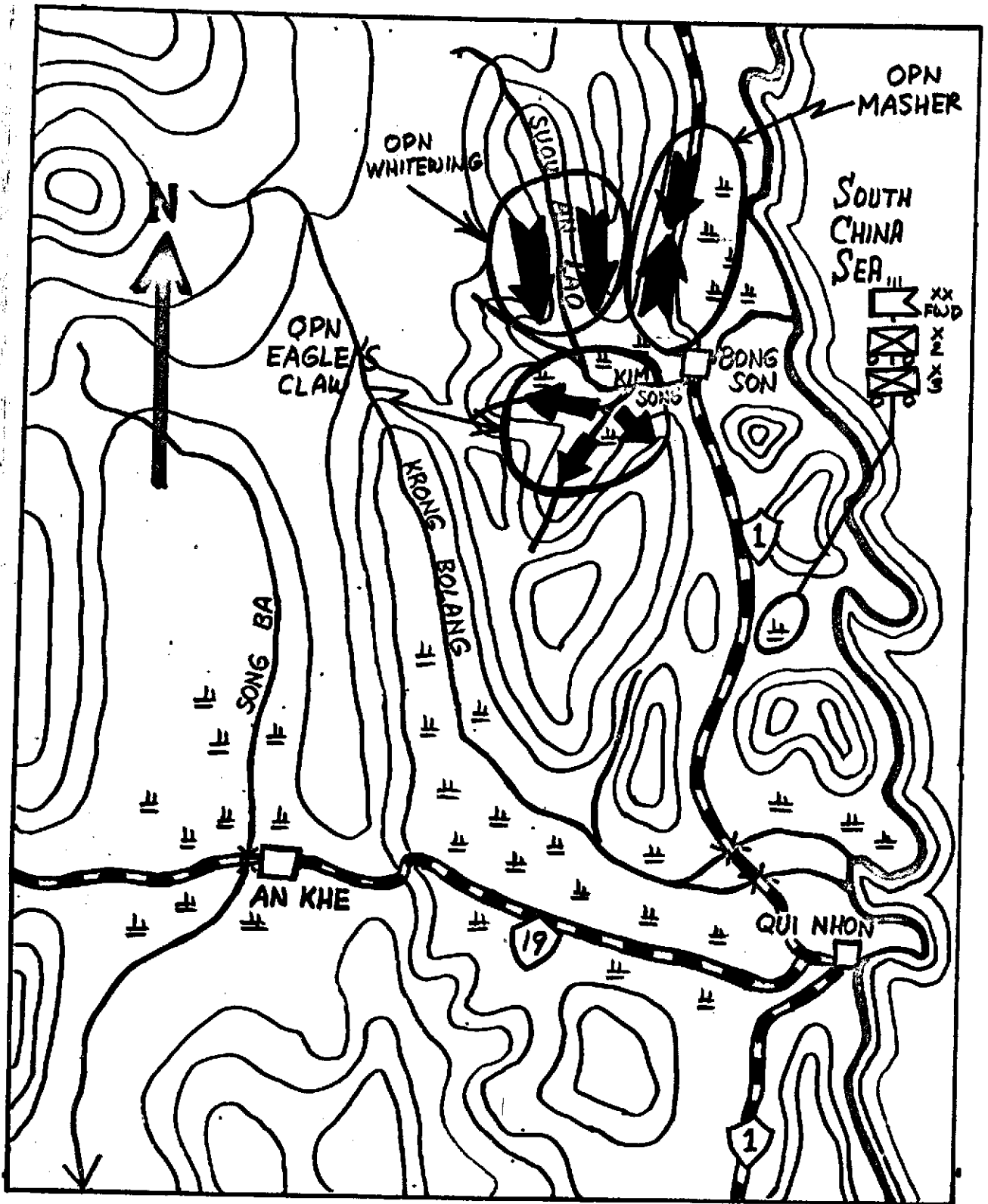

SCALE
 0 KILOMETERS 100

MAP "B"

NORTHEASTERN BINH DINH PROVINCE
 (1ST CAVALRY DIVISION'S OPERATIONS)

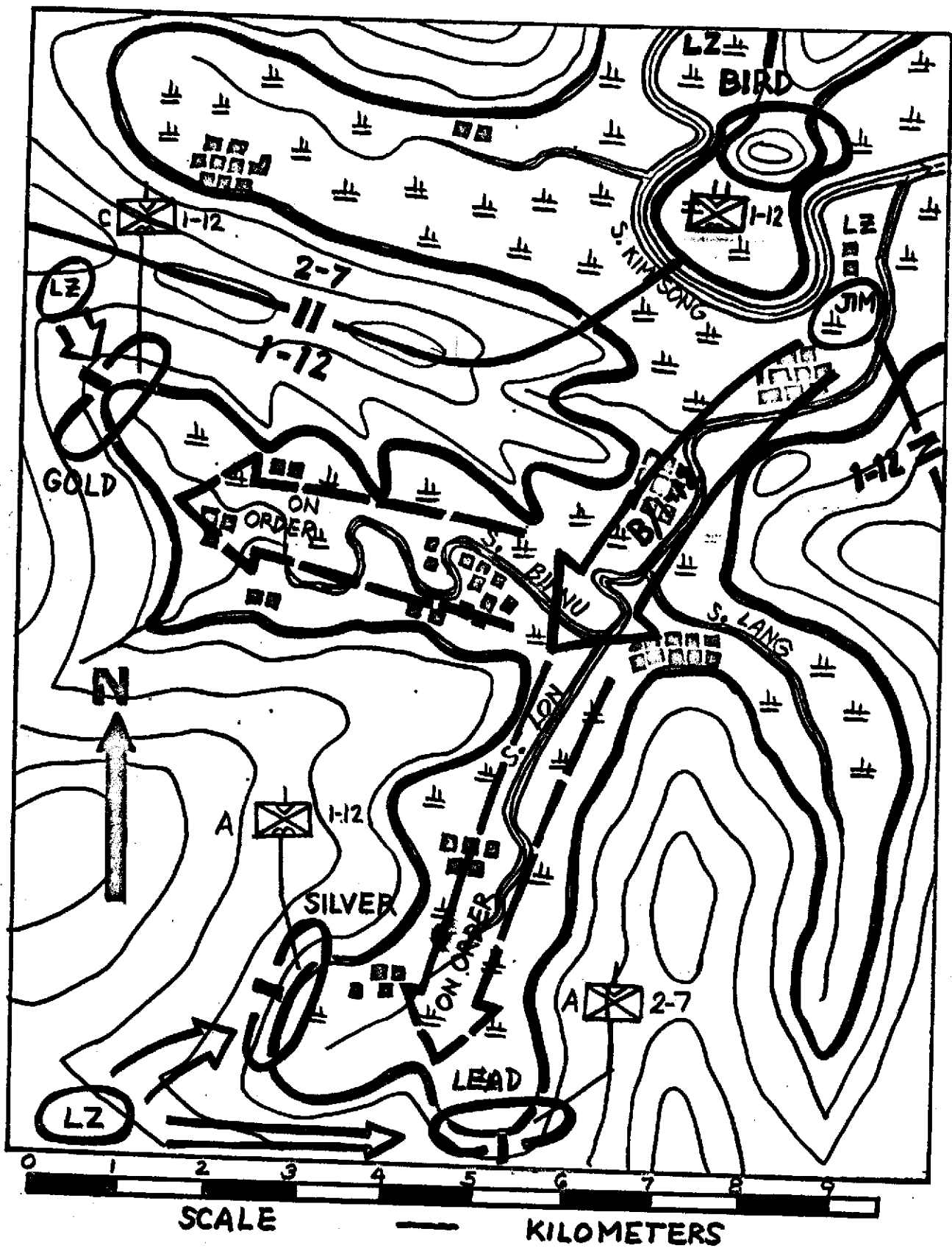

MAP "C"
 THE EAGLE'S CLAW
 (1-12 CAVALRY PLAN OF OPERATION)

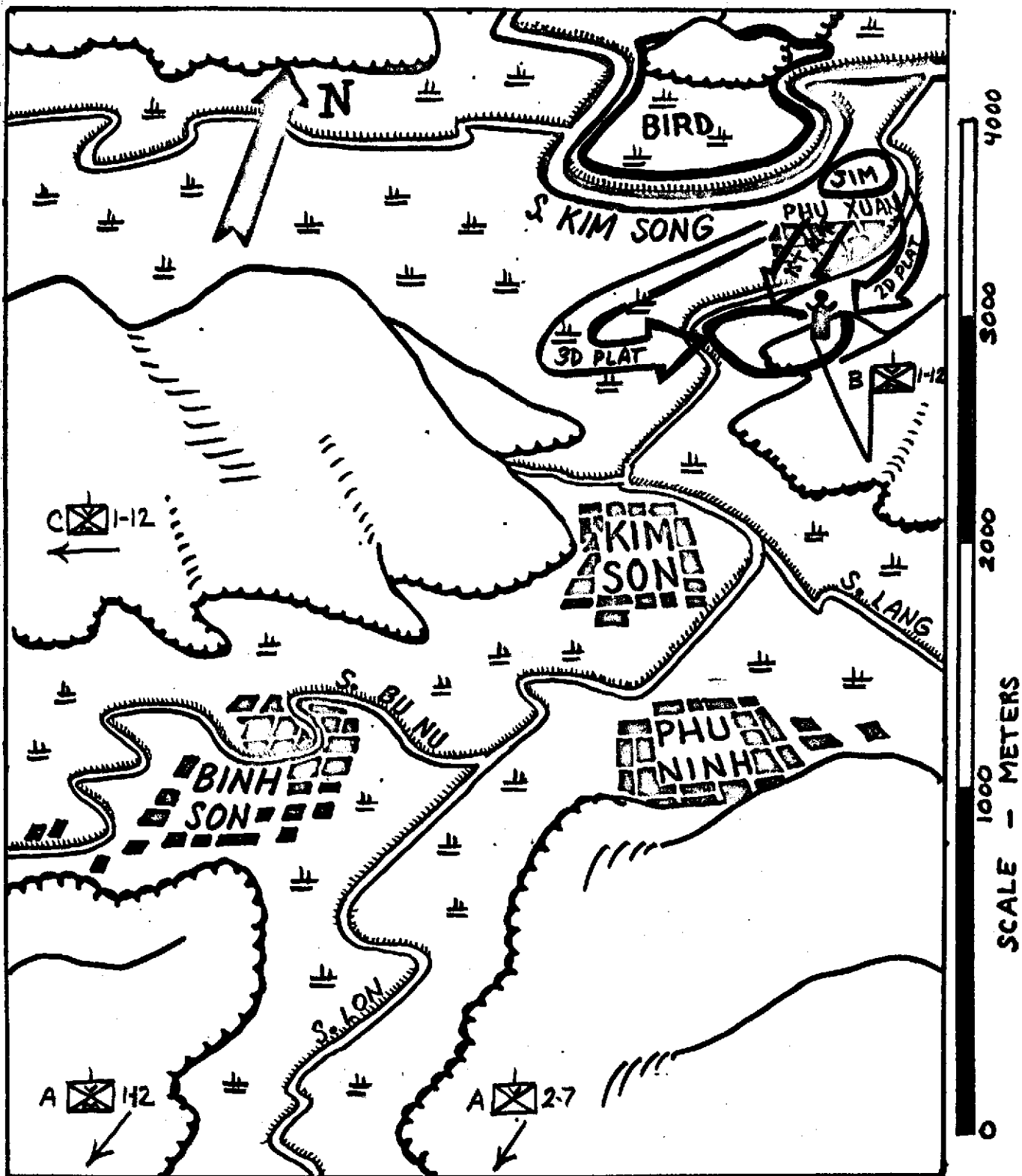

MAP "D"

THE EAGLE'S CLAW

(B COMPANY'S OPERATIONS ON 12 FEBRUARY)

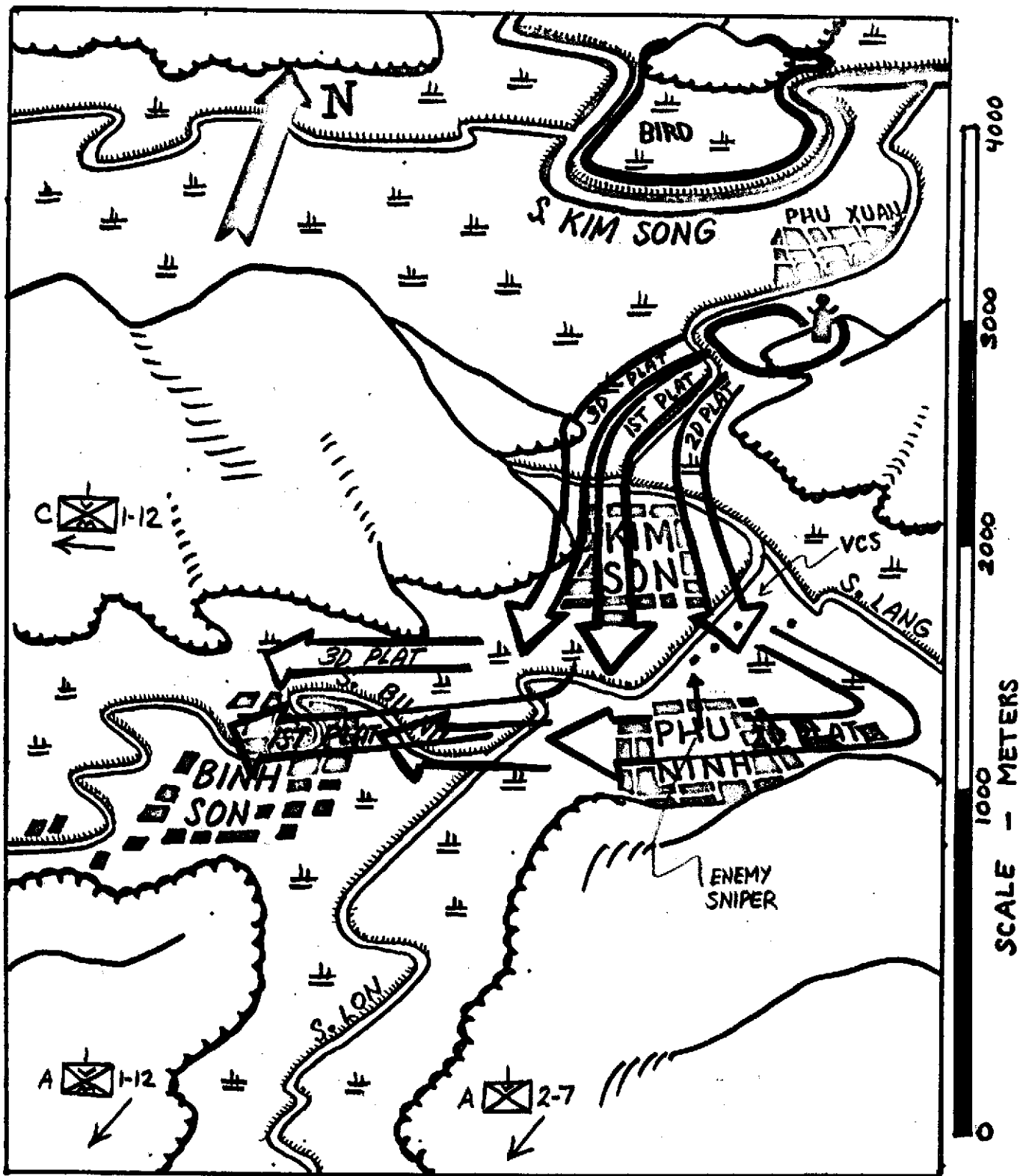

MAP "E"

THE EAGLE'S CLAW

(B COMPANY'S MOVEMENT TO CONTACT ON 13 FEBRUARY)

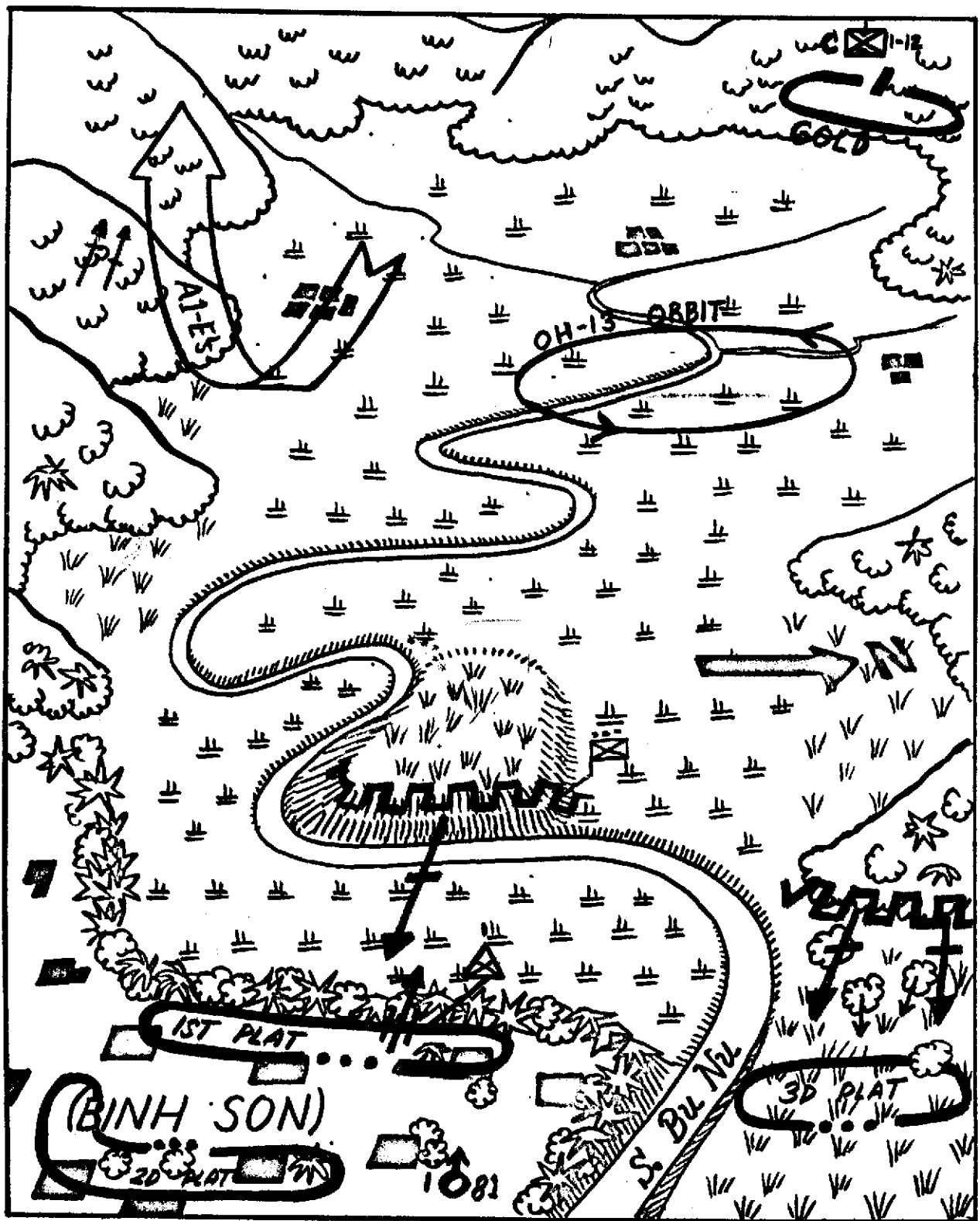

MAP "F"

THE EAGLE'S CLAW

(FRIENDLY AND ENEMY DISPOSITIONS ON 13 FEBRUARY)

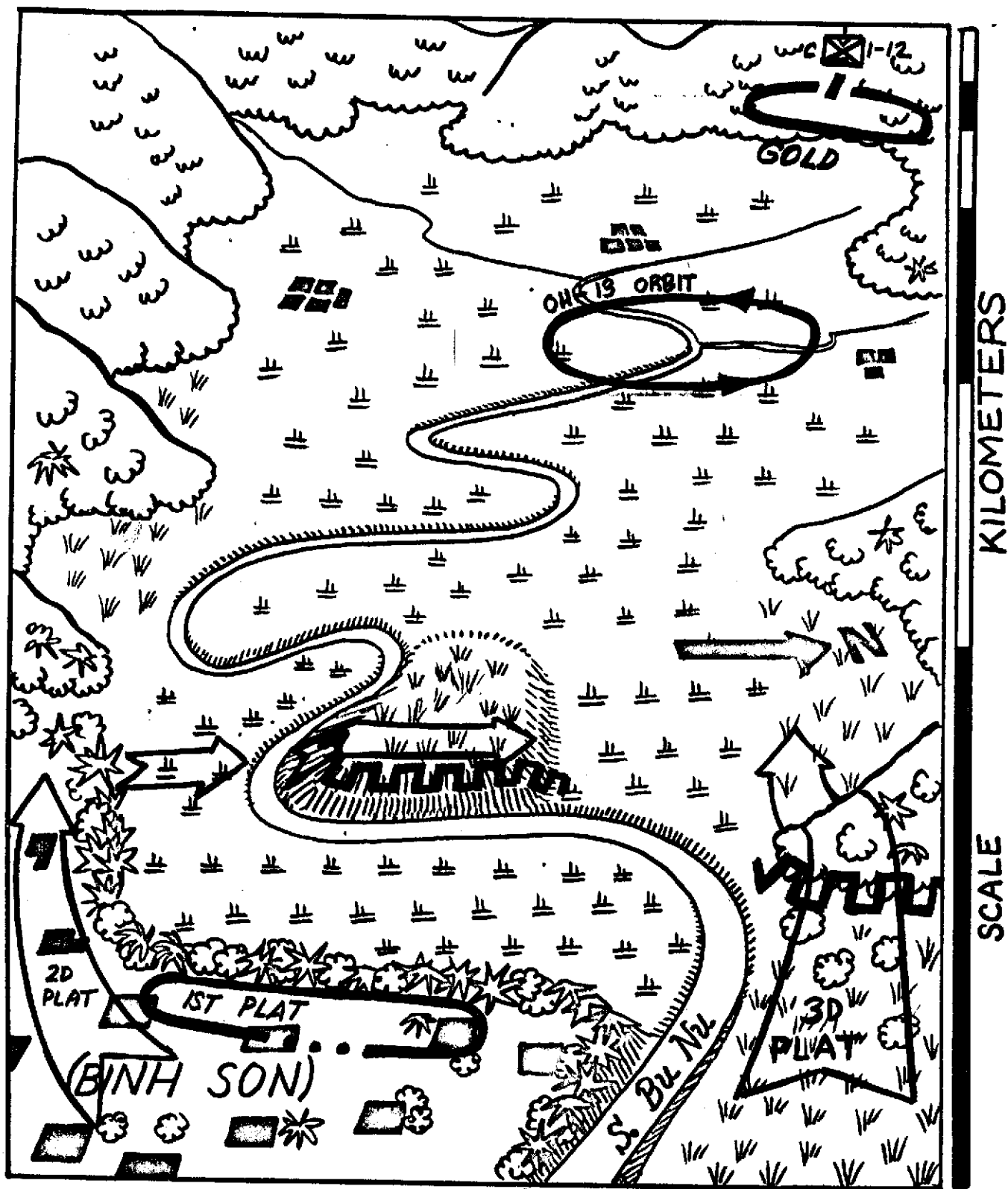

MAP "G"

THE EAGLE'S CLAW

(THE ASSAULT ON 13 FEBRUARY)

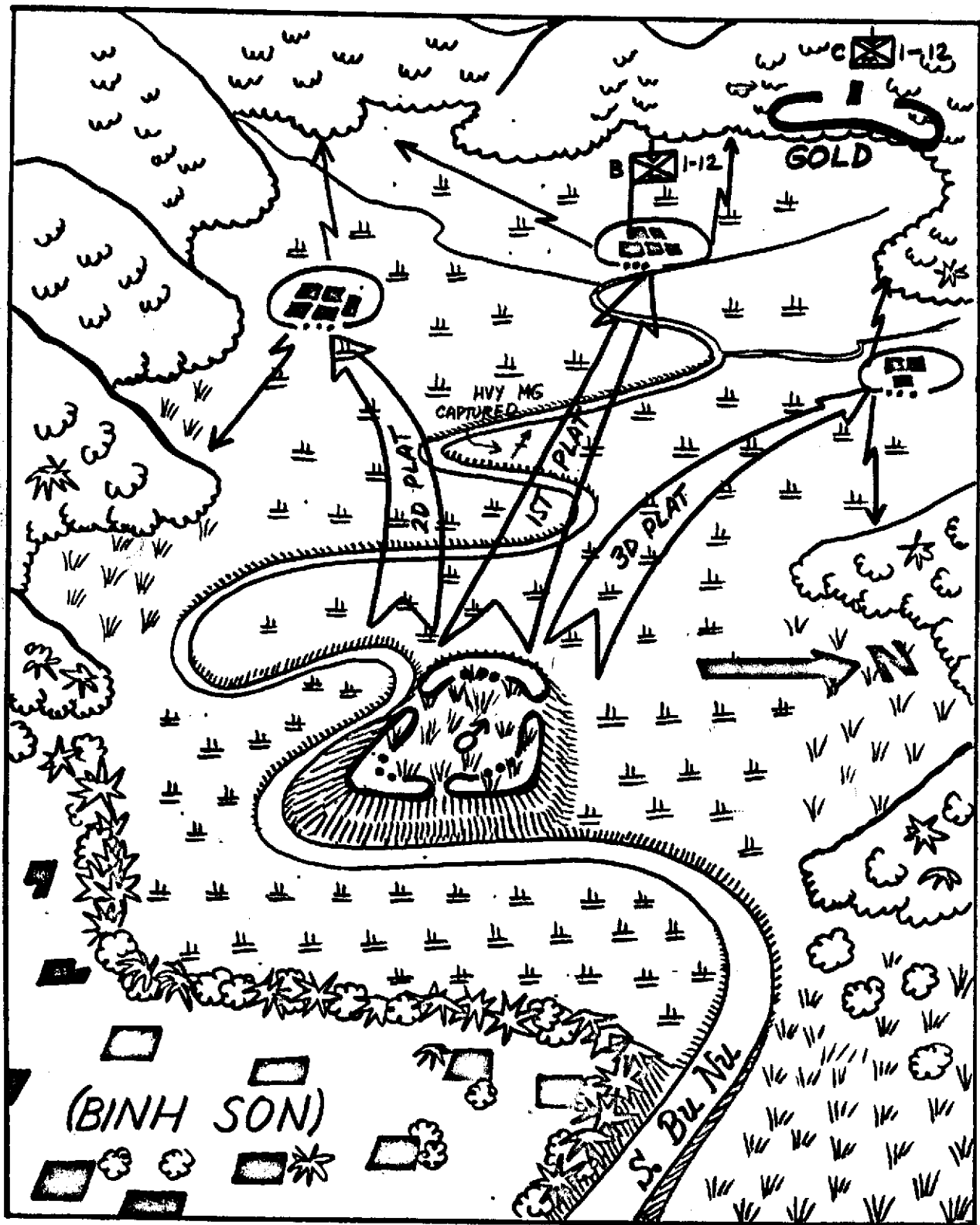

MAP "H".

THE EAGLE'S CLAW

(CONSOLIDATION ON 13 FEBRUARY; ACTIVITIES ON 14 AND 15 FEBRUARY)